

# LG-ITR2C-502725-3.1

## DATA SHEET

SPEC.NO.: SZ18080411  
DATE: 2021/02/20  
REV. A/4

Approved By:

Checked By:

Prepared By:

# LIGHT

---

## Package Dimensions

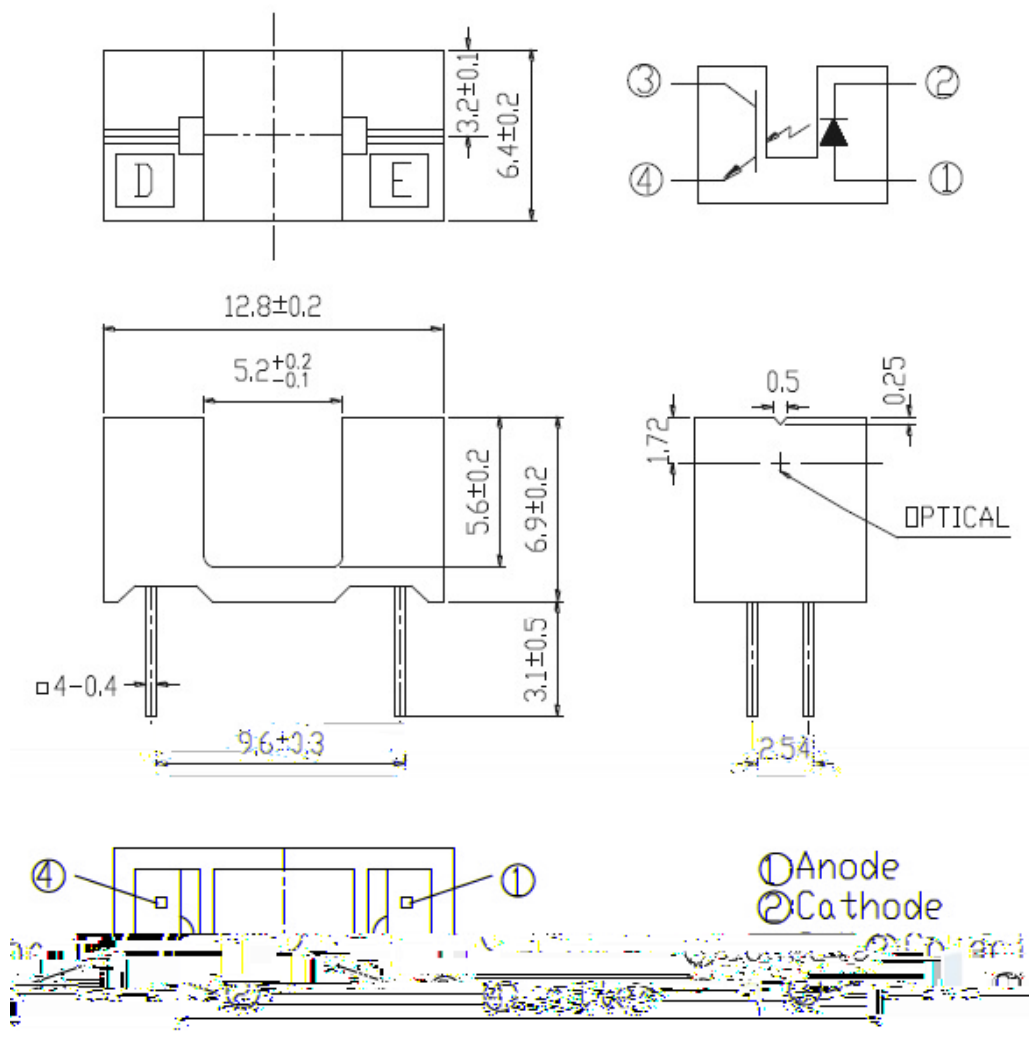

### Notes:

1. All dimensions are in millimeters.
2. Tolerances unless dimensions  $\pm 0.2$ mm.

### Absolute Maximum Ratings (Ta=25 )

Parameter		Symbol	Ratings	Unit
Input	Power Dissipation at(or below) 25 Free Air Temperature	$P_d$	75	mW
	Reverse Voltage	$V_R$	5	V
	Forward Current	$I_F$	50	mA
	Peak Forward Current(*1) Pulse width 100μs, Duty cycle=1%	$I_{FP}$	1	A
Output	Collector Power Dissipation	$P_C$	75	mW
	Collector Current	$I_C$	20	mA
	Collector-Emitter Voltage	$V_{CEO}$	30	V
	Emitter-Collector Voltage	$V_{ECO}$	5	V
Operating Temperature		$T_{opr}$	-25~ +85	
Storage Temperature		$T_{stg}$	-40~ +85	
Lead Soldering Temperature (*2) (1/16 inch from body for 5 seconds)		$T_{sol}$	260	

(\*1)  $t_w = 100 \mu\text{sec.}$ ,  $T = 10 \text{ msec.}$  (\*2)  $t = 5 \text{ Sec.}$

### Electro-Optical Characteristics (Ta=25 )

Parameter		Symbol	Min.	Typ.	Max.	Unit	Condition
Input	Forward Voltage	$V_F$	---	1.2	1.6	V	$I_F = 20\text{mA}$
	Reverse Current	$I_R$	---	---	10	μA	$V_R = 5\text{V}$
	Peak Wavelength	$\lambda_p$	--	940	---	nm	$I_F = 20\text{mA}$
Output	Collector Dark Current	$I_{CEO}$	---	---	100	nA	$V_{CE} = 10\text{V}$ , E D

命%00

啓懃1

## Typical Electrical/Optical/Characteristics Curves for IR

Fig.1 Forward Current vs. Ambient Temperature

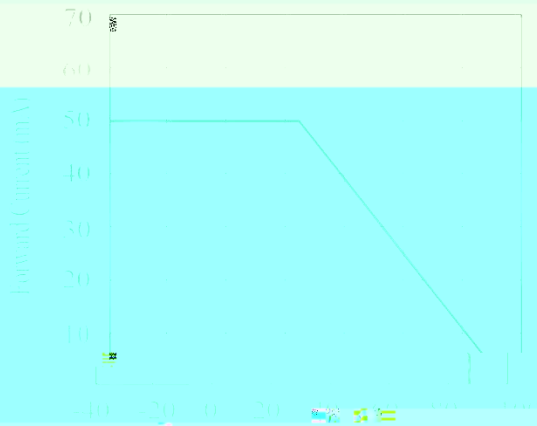
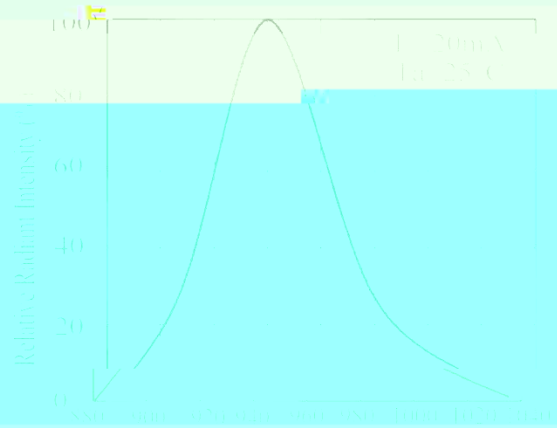
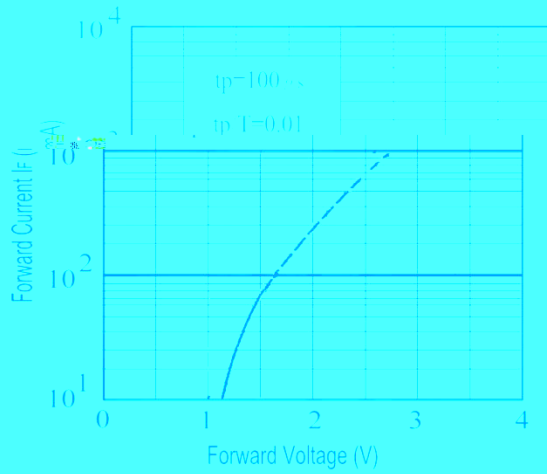

Fig.2 Spectral Distribution



Forward Voltage



Angular Displacement

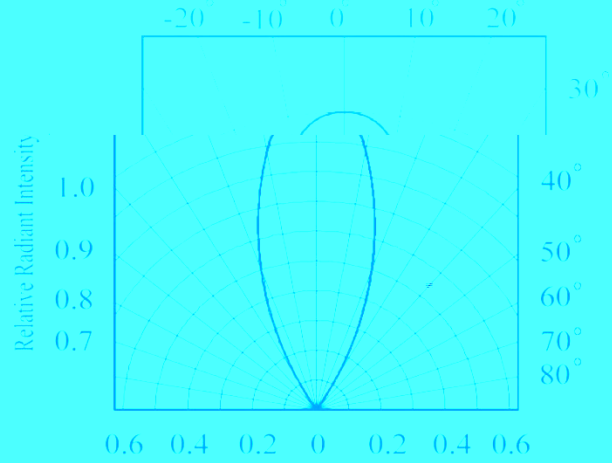

## Typical Electrical/Optical/Characteristics Curves for PT

Fig.1 Spectral Sensitivity

Fig.2 Collector Current vs. Irradiance

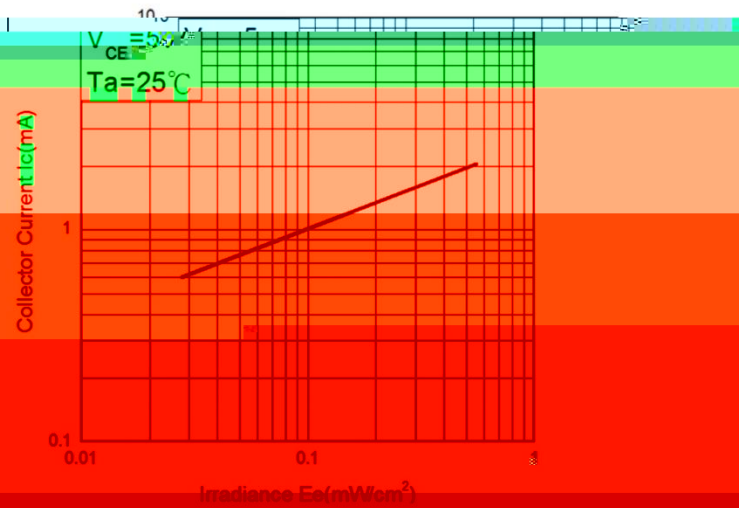
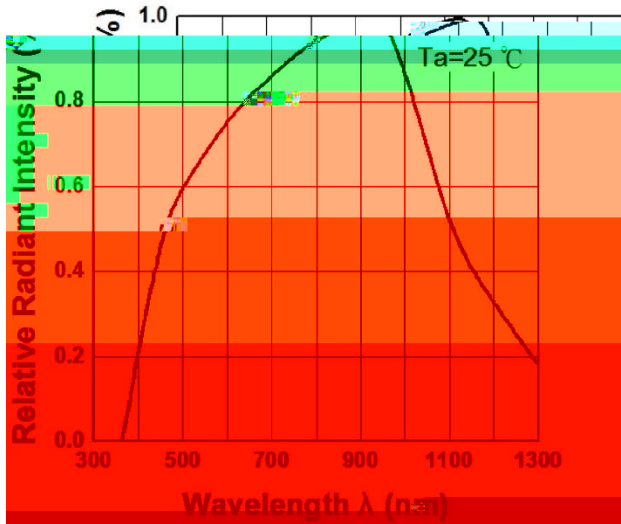

Fig.3 Collector Current vs. Collector Voltage

