

LIGHT

LIGHT ELECTRONICS CO., LTD.

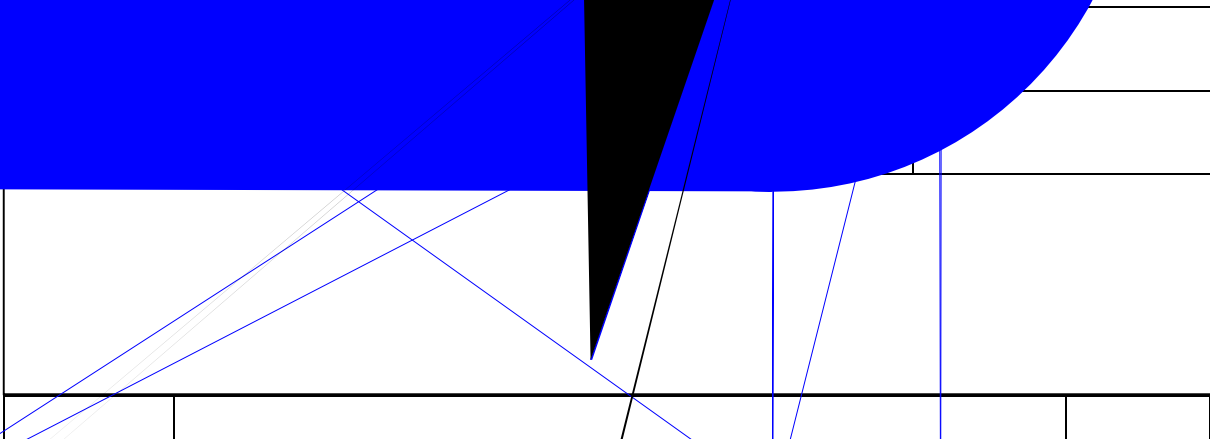

LIGHT ELECTRONICS CO., LTD.

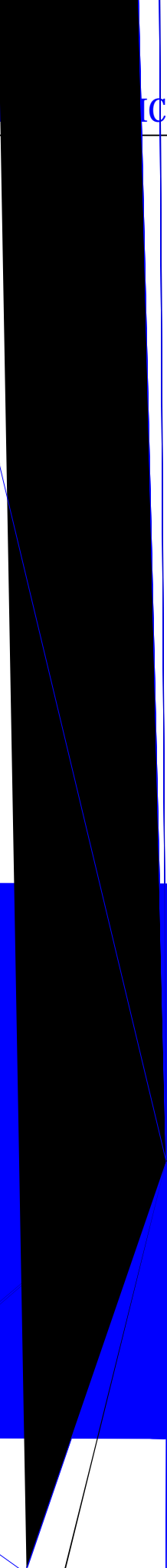
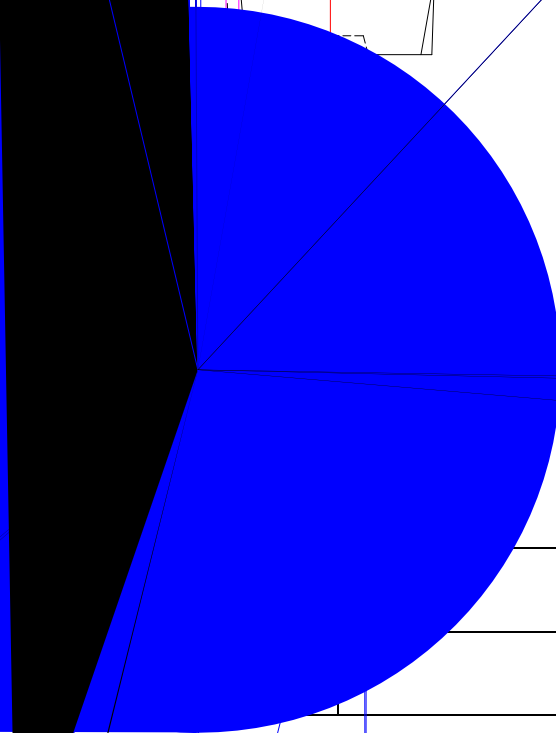
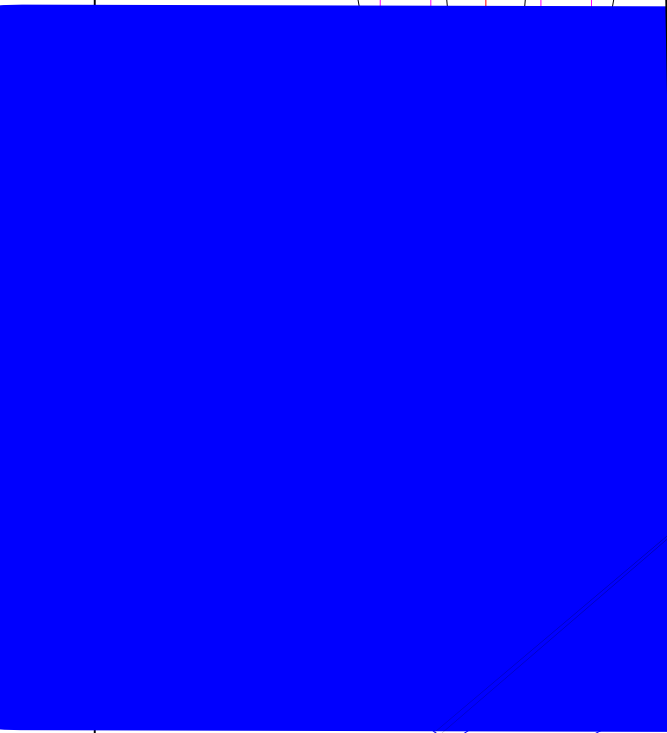
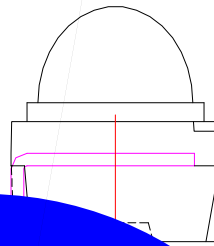
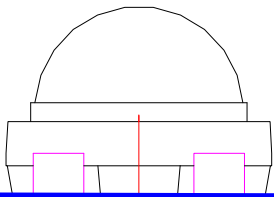
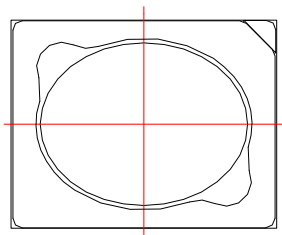

	2					
Peak Wavelength	p	---	940	---	nm	I
		---	50	---	nm	I

2

	21	26
	26	31
	31	37
	37	44
	44	53



--	--	--	--

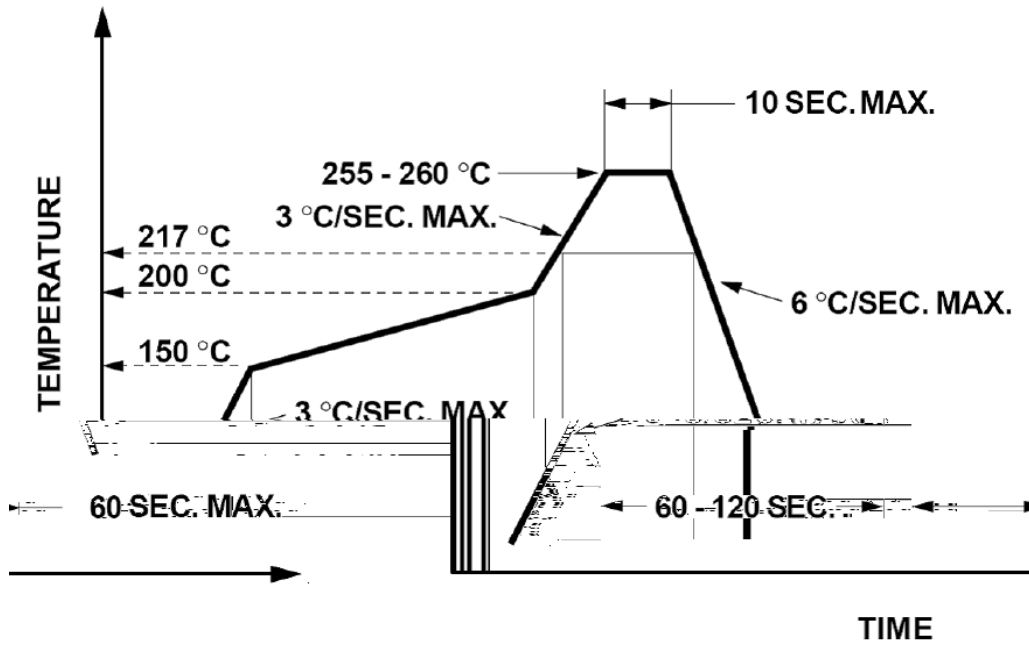

°C

