

## SL-T2835UVAC120-L70 DATA SHEET

SPEC. NO. : SZ19112002  
DATE : 2019/11/20  
REV. : A/0

Approved By:

Checked By:

Prepared By:

## Features

- ◆ Pb free product    RoHS compliant
- ◆ Low power consumption, High efficiency
- ◆ Reliable and rugged
- ◆ Long life    solid state reliability
- ◆ Radiant angle: 120 °
- ◆ Peak Wavelength: 395nm

## Package Dimension

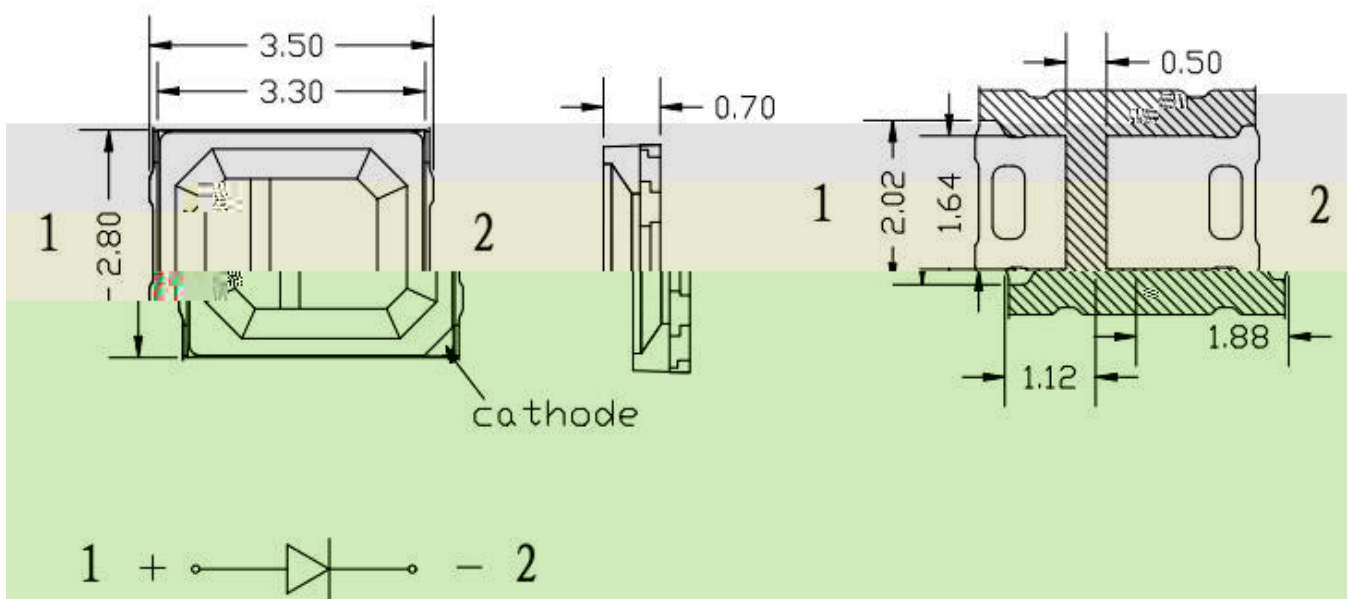

Part NO.	Chip Material	Lens Color
SL-T2835UVAC120-L70	GaN	Water Clear

### Notes:

1. All dimensions are in millimeters.
2. Tolerance is  $\pm 0.10$ mm unless otherwise noted
3. Specifications are subject to change without notice.

## Absolute Maximum Ratings at Ta=25

Parameter	MAX.	Unit
Power Dissipation	480	mW
Continuous Forward Current	120	mA
Peak Forward Current <sup>*2</sup>	150	mA
Reverse Voltage	5	V
Electrostatic Discharge (HBM) <sup>*3</sup>	2000	V
Moisture Sensitivity Level <sup>*1</sup>	5a	
Operating Temperature	-40 to + 85	
Storage Temperature	-40 to + 100	
IR Reflow Temperature	260 for 10 Seconds MAX.	

### 1. Storage

- (1). Storage requirements before vacuum bag opened: Temperature<30 , Humidity<65%RH;
- (2). Check air leakage and vacuum bag damage before opened. If there is any issue found, check the humidity indicator card immediately after bag opened:
  - a. components can be used without additional handling;
  - b. If color changes on both 10% and 20% circles but not the circles of 30% and above, components must be dehumidified according to the conditions of bullet (5);
  - c. If color changes on 10%, 20%, and 30% circle or above, the product should be returned to the supplier for high temperature dehumidification;
- (3). After bag opened, manual soldering or reflow process must follow the following requirements:
  - a. Complete soldering / reflow within 24 hours;
  - b. Requirements of working environment: Temperature<30 , Humidity<60%RH;
- (4). If the working condition is outside (3)a or (3)b requirement, the components must be dehumidified according to the conditions of bullet (5);
- (5). Low temperature dehumidification: temperature 60±5 , at least 24 hours;
- (6). dehumidified according to the condition of bullet (5). If customer is unable to dehumidify, return components to LIGHT for dehumidification.

### 2. Peak Forward Current:

Condition for is IFP pulse: duty 0%.

### 3. Caution in ESD:



Static Electricity and surge damages the LED. It is recommend to use a wrist band or anti-electrostatic glove when handling the LED. All devices, equipment and machinery must be properly grounded.







## Label Explanation

LIGHT Universal Label

<b>LIGHT</b>		
Light Electronics CO., LTD.		
MODEL NAME: _____		LOT NO. : _____
QUANTITY: _____		
BIN: _____		
PACKING DATE: _____		
REMARKS: _____		

Customer Defined Label

<b>LIGHT</b>		
Light Electronics CO., LTD.		
MODEL NAME: _____		LOT NO. : _____
QUANTITY: _____		
BIN: _____		
PACKING DATE: _____		
CUSTOMER P/N: _____		

## Reel Dimensions

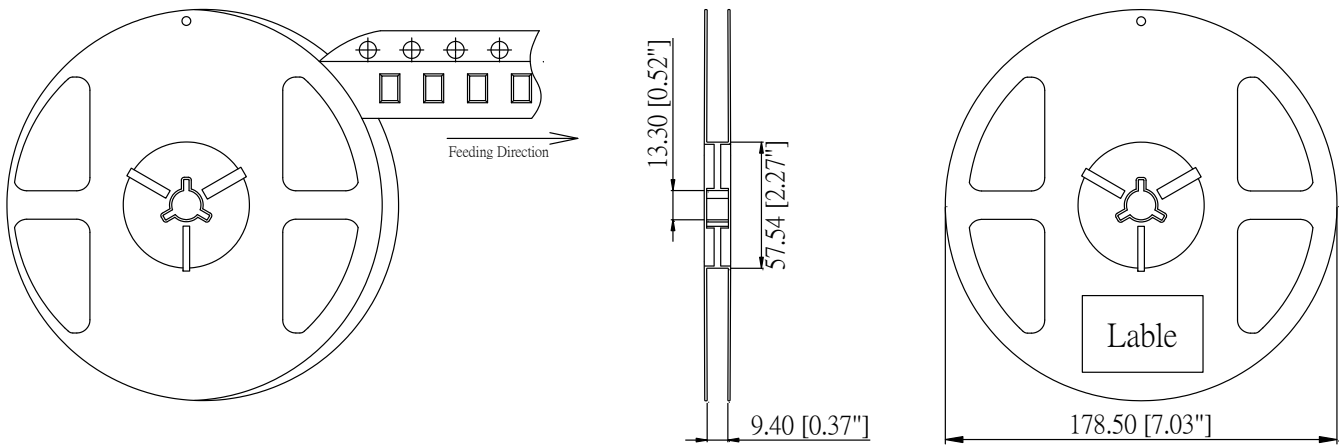

**Note:** Tolerance unless mentioned is  $\pm 0.2\text{mm}$ ; Unit = mm

## Carrier Tape Specifications

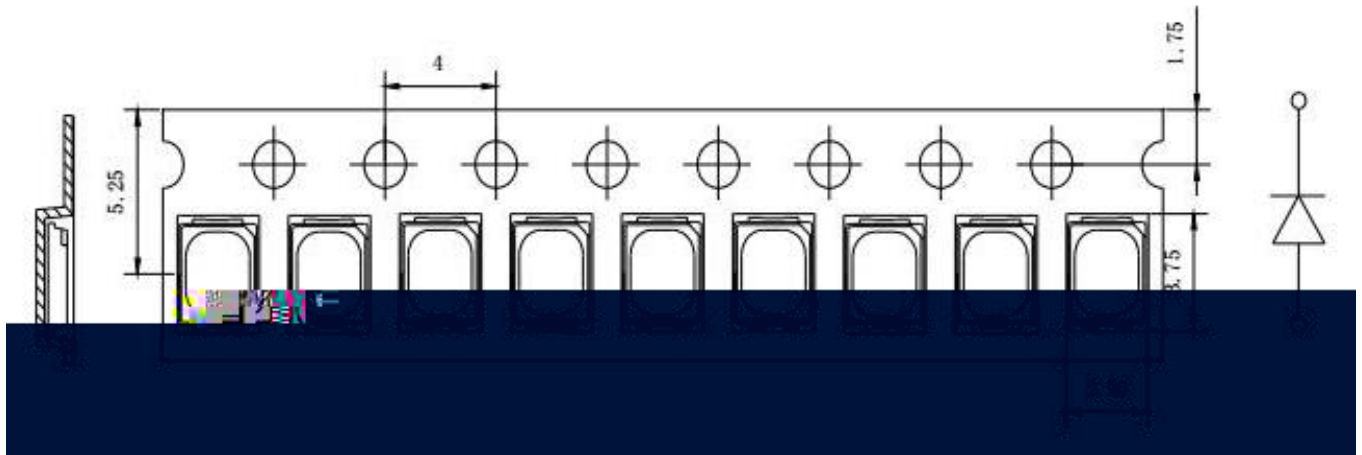

**Note:** Tolerance unless mentioned is  $\pm 0.1$  mm; Unit = mm

## Moisture Resistant Packaging

## Suggest IR Reflow Condition For Lead Free

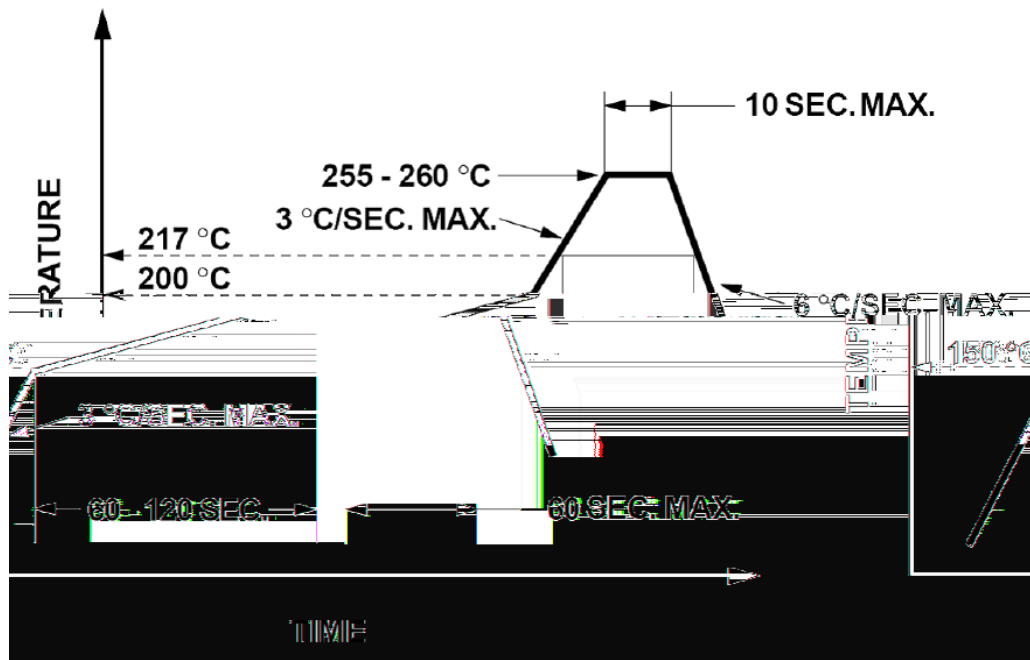

1. Reflow soldering should not be done more than two times.
2. When soldering, do not put stress on the LEDs during heating.

## Soldering iron

1. When hand soldering, the temperature of the iron must less than 300 for 3 seconds.
2. The hand solder should be done only once.

## Repairing

Repair should not be done after the LEDs have been soldered. When repairing is unavoidable, a double-head soldering iron should be used (as below figure). It should be confirmed beforehand whether the characteristics of LEDs will or will not be damaged by repairing.

